

**Vice grips
10kN and 20kN**

Ordering information

TH154 are supplied in pairs, but can also be ordered as single grip (0.5 pair).

Grips and jaws need to be ordered separately.

Jaws with other dimensions and surface coatings on request.

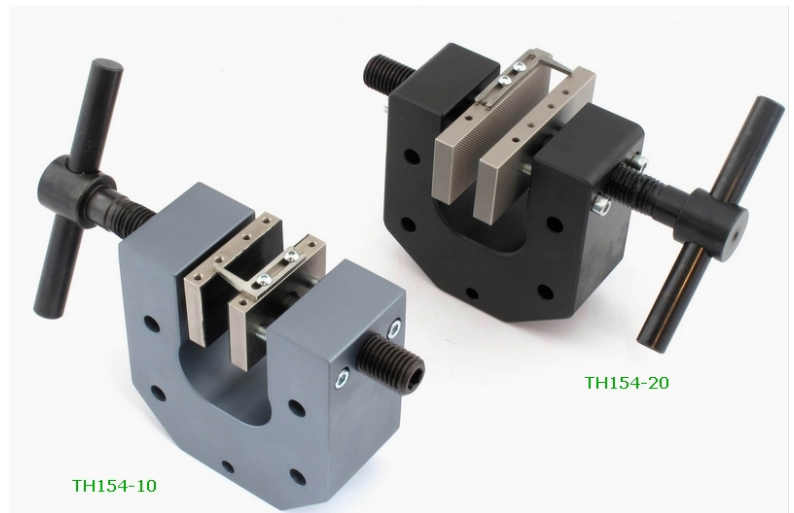

Item No.	TH154-10	TH154-20
Tensile force	10 kN	20 kN
Temperature range	0°C - +180°C	0°C - +350°C -70°C - +350°C (TH154-20-NI)
Body	Aluminum, anodized	Steel, manganese phosphated
Weight	2.36 kg each grip (without jaws)	5 kg each grip (without jaws)
Scope of delivery	1 pair	1 pair









TH154-20-Ni – nickel plated
Temperature range -70 to +350°C

Jaws for TH154: Scope of delivery: 1 set = 4 jaws

Item No.	Surface	Clamping surface H x W	Opening	Weight per pair
TH154-B	Blank jaws	40 x 60 mm	0 – 34 mm	0.35 kg
TH154-BG	Rubber jaws	40 x 60 mm	0 – 32 mm	0.36 kg
TH154-BP	Pyramid jaws	40 x 60 mm	0 – 34 mm	0.33 kg
TH154-BV4*	V-jaws	Clamping height 40 mm	4 – 30 mm Ø	0.35 kg
TH154-BV8*	V-jaws	Clamping height 40 mm	8 – 34 mm Ø	0.32 kg
TH154-BW	Wave jaws	40 x 60 mm	0 – 34 mm	0.32 kg
TH154-BD	Diamond jaws	40 x 60 mm	0 – 34 mm	0.35 kg
TH154-BWC	Jaws for bitumen	40 x 60 mm	0 – 14 mm	0.63 kg
TH154-B100	Blank jaws	40 x 100 mm	0 – 30 mm	0.72 kg
TH154-BG100	Rubber jaws	40 x 100 mm	0 – 28 mm	0.74 kg
TH154-BP100	Pyramid jaws	40 x 100 mm	0 – 30 mm	0.69 kg
TH154-BW100	Wave jaws	40 x 100 mm	0 – 30 mm	0.66 kg
TH154-BD100	Diamond jaws	40 x 100 mm	0 – 30 mm	0.72 kg
TH154-BW200	Wave jaws*	60 x 200 mm	0 – 22 mm	3.00 kg

*We recommend BV8 jaws for samples with a larger diameter

	Blank jaws • Suitable for own further treatments • Steel blanks without coating
	Rubber jaws • 1mm rubber coating (NBR) • Nickel plated
	Pyramid jaws • Pyramids 1.2x45° • Hardened steel 58HRC • Nickel plated
	V-jaws • For all kinds of round samples • Tooth pitch 1.2 mm • Hardened steel 58HRC, nickel plated
	Wave jaws • For flexible materials • Wave 5 mm • Hardened steel 58HRC, nickel plated
	Diamond jaws • Covered with synthetic diamonds • Nickel plated

Inset jaws for TH154

Quick change system of jaw surfaces without any additional tools.

Inset jaws require carriers (TH154-GT.) Scope of delivery: 1 set = 4 jaws

Item No.	Surface	Clamping surface H x W	Opening	Weight per pair
TH154-GT	Carrier	-		0.33 kg
TH154-EB	Blank inset jaws	50 x 60 mm	0 – 22 mm	0.29 kg
TH154-EBG	Rubber inset jaws	50 x 60 mm	0 – 22 mm	0.30 kg
TH154-EBP	Pyramid inset jaws	50 x 60 mm	0 – 24 mm	0.28 kg
TH154-EBV4	V- Inset jaws	Clamping height 50 mm	4 – 24 mm Ø	0.29 kg
TH154-EBW	Wave inset jaws	50 x 60 mm	0 – 24 mm	0.26 kg
TH154-EBD	Diamond inset jaws	50 x 60 mm	0 – 24 mm	0.29 kg
TH154-GT100	Carrier	-		0.69 kg
TH154-EB100	Blank inset jaws	50 x 100 mm	0 – 16 mm	0.63 kg
TH154-EBG100	Rubber inset jaws	50 x 100 mm	0 – 14 mm	0.65 kg
TH154-EBP100	Pyramid inset jaws	50 x 100 mm	0 – 16 mm	0.60 kg
TH154-EBW100	Wave inset jaws	50 x 100 mm	0 – 16 mm	0.57 kg
TH154-EBD100	Diamond inset jaws	50 x 100 mm	0 – 16 mm	0.63 kg

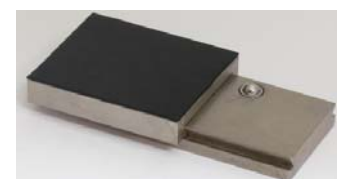

TH154-GT with TH154-EBG

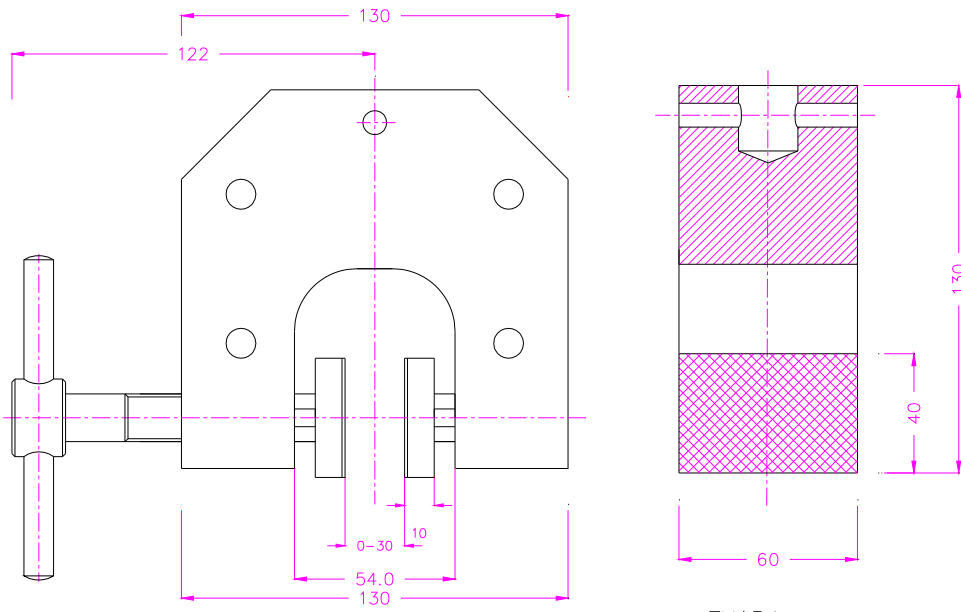

TH154

Examples for special solutions:

