

TH204

wedge grip
less height big load
simple usage

universal grip
with a front gear to open and close
and a flap to allow big load

wedge move down and make a preload of
10kN
even hard sample are kept

50 kN (100kN**)
11 kg
156x156x200mm



TH204-BP20

pyramid jaw
samples for 0-20mm thickness
size 50x73mm

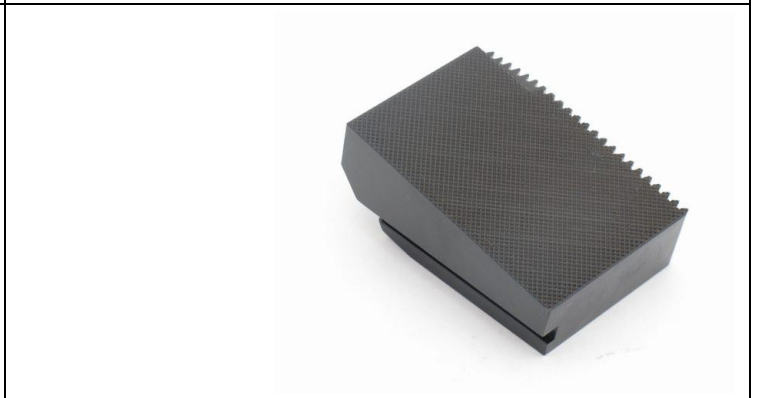

TH204-BV35

V-Jaw for round samples up to 35mm

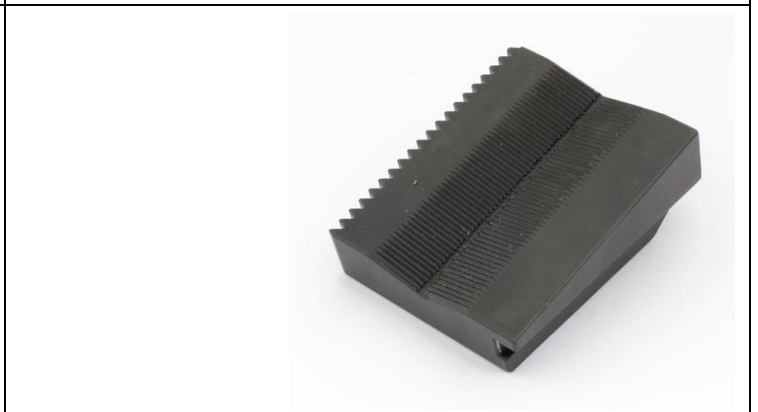

<p>TH204-EBP20</p> <p>pyramid jaws for sample 0-20mm 40x60mm Insert jaws double usage (can be used 180° turned)</p>	
<p>TH204-EBV30</p> <p>V-jaws for round samples 10 to 30mm Ø 40x60mm Insert jaws double usage</p>	
<p>TH204-GT</p> <p>carrier for EBP and EBV jaws</p>	
<p>TH204-Mo</p> <p>motorized version 50kN</p>	

** 100kN only with closed flap and weak steel without pushback

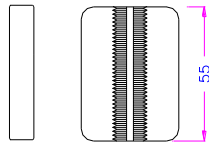
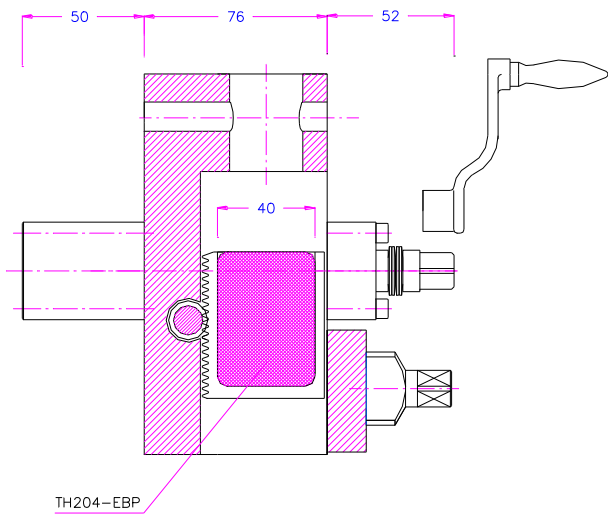
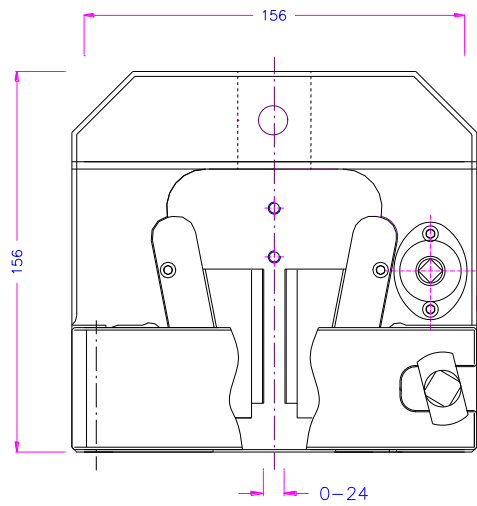

TH204-EBV26 10-26 ϕ

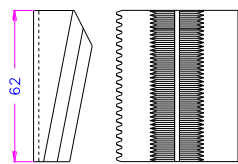

TH204-BV35 25-35 ϕ

50 kN 11 kg

TH 204

TH204-B jaws

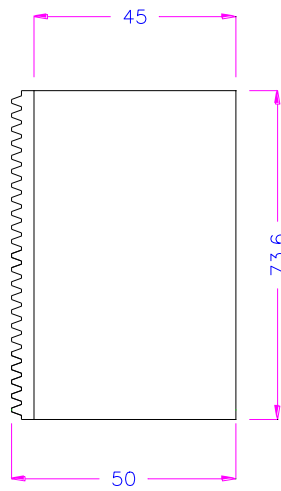
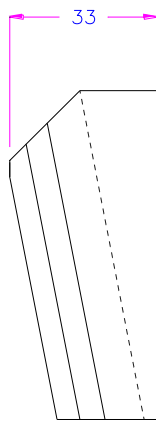
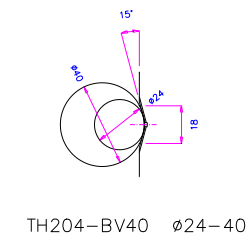
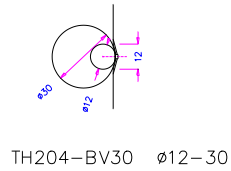
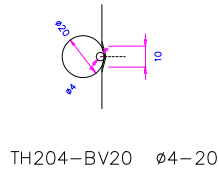
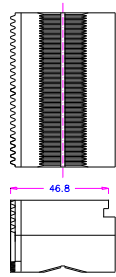
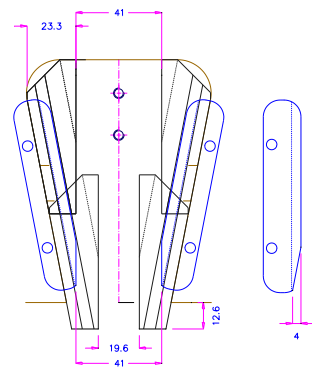
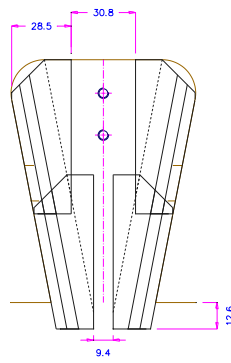
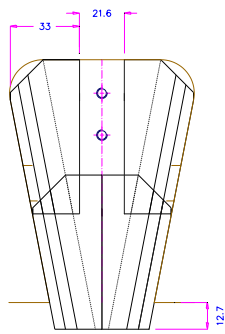
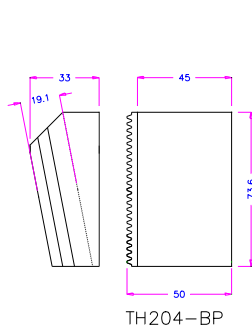

TH204-EB insert jaws

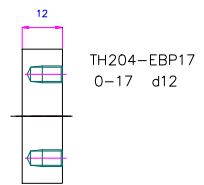
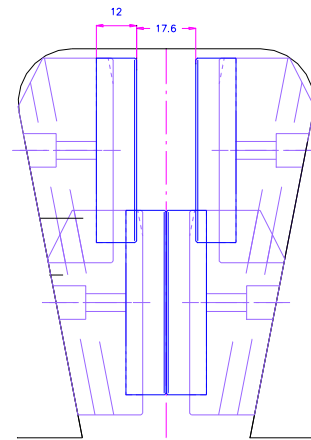
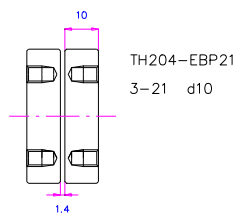
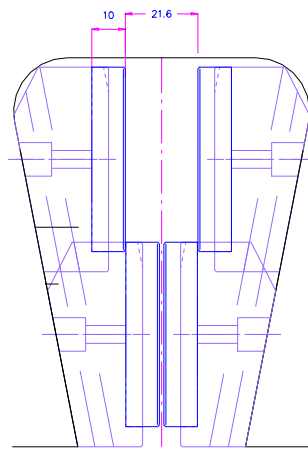
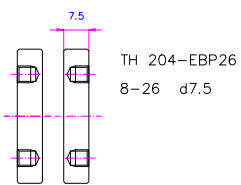
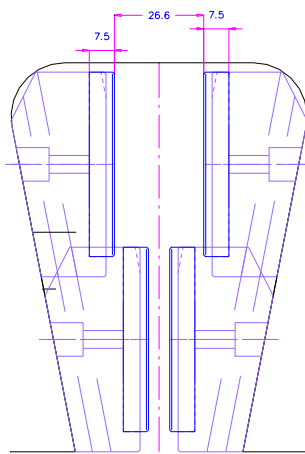
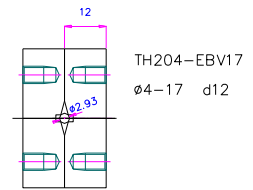
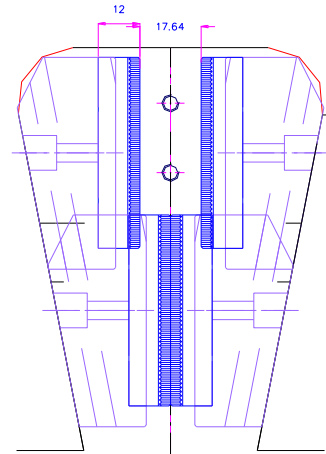
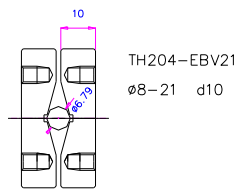
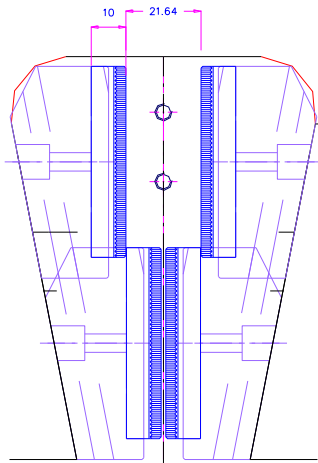
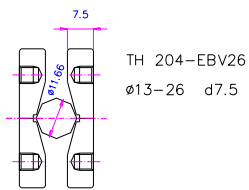
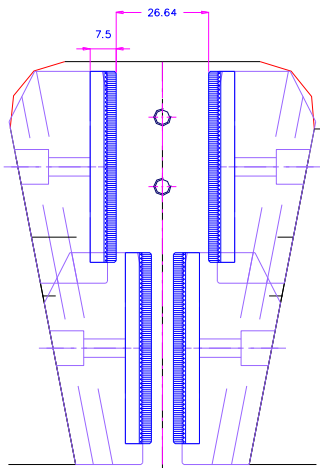

TH204	Keilspannzeug 1 Paar, für Drähte, Rundproben, Flachproben etc...	Wedge grip 1 pair, for wires, round samples, flat samples etc ...
TH204-M	Keilspannzeug mit Servomotor	motorized wedge grip 50 kN
	Einsatzbacken für TH204 - 1 Set = 4 Backen	Inset jaw faces for TH204 - 1 set = 4 jaw faces
TH204-EBP17	Pyramideneinsatzbacken 1mmx45° Proben 0-17mm, 1Set	Pyramid (serrated) inset jaws 1mmx45° samples 0-17 mm 1 set
TH204-EBP21	Pyramideneinsatzbacken 1mmx45° Proben 3-21mm, 1Set	Pyramid (serrated) inset jaws 1mmx45° samples 3-21 mm 1 set
TH204-EBP26	Pyramideneinsatzbacken 1mmx45° Proben 8-26mm, 1Set	Pyramid (serrated) inset jaws 1mmx45° samples 8-26 mm 1 set
TH204-EBV17	V-Backen Einsatzbacken für Proben Ø 4-17 mm, 1 Set	V-inset jaws for round samples Ø 4-17mm, 1 Set
TH204-EBV21	V-Backen Einsatzbacken für Proben Ø 8-21 mm, 1 Set	V-inset jaws for round samples Ø 8-21mm, 1 Set
TH204-EBV26	V-Backen Einsatzbacken für Proben Ø 13-26 mm, 1 Set	V-inset jaws for round samples Ø 13-26mm, 1 Set
TH204-EBD17	Diamantbeschichtete Einsatzbacken, 0-17mm, 1 Set	Diamond coated inset jaws for samples 0-17 mm, 1 Set
TH204-EBD21	Diamantbeschichtete Einsatzbacken, 3-21 mm, 1 Set	Diamond coated inset jaws for samples 3-21 mm, 1 Set
TH204-EBD26	Diamantbeschichtete Einsatzbacken, 8-26mm, 1 Set	Diamond coated inset jaws for samples 8-26 mm, 1 Set
TH204-GK	Grundträger für Einsatzbacken, 4 Stück	Carrier für Insert jaws, 4 parts
	Keil-Backen für TH204 - 1 Set = 4 Keil - Backen	Wedge jaws for TH204 - 1 set = 4 wedge jaws
TH204-BP20	Keilpyramidenbacken für Flachproben 0-20 mm, 1 Set	Pyramid wedge jaws for flat samples, 0-20 mm, 1 Set
TH204-BP30	Keilpyramidenbacken für Flachproben 10-30 mm, 1 Set	Pyramid wedge jaws for flat samples, 10-30 mm, 1 Set
TH204-BP40	Keilpyramidenbacken für Flachproben 20-40 mm, 1 Set	Pyramid wedge jaws for flat samples, 20-40 mm, 1 Set
TH204-BV20	V-Keilbacken für Rundproben 4-20 mm Ø, 1 Set	V-Wedge jaws for round samples 4-20 mm Ø, 1 Set
TH204-BV30	V-Keilbacken für Rundproben 12-30 mm Ø, 1 Set	V-Wedge jaws for round samples 12-30 mm Ø, 1 Set
TH204-BV40	V-Keilbacken für Rundproben 24-40 mm Ø, 1 Set	V-Wedge jaws for round samples 24-40 mm Ø, 1 Set
	Weitere Öffnungsweiten auf Anfrage	Further jaws for different openings on request

Videos	
	<p>12mm steel (Silberstahl) 82 kN http://youtu.be/NSEKIs7GaUI</p>
	<p>14mm steel (Silberstahl) 100 kN http://youtu.be/dm0T7Hg0ka8</p>
	<p>glued wood sample 8kN http://youtu.be/YVnNNnK_mTY</p>