

TH22-800-240-WNJ30-Am318

4 point Bending fixture
see attached drawing
special Supports rotateable in 2 directions
fixed with springs
X axe $\pm 2.3^\circ$ fixable
Y axe $\pm 20^\circ$ support with surface 30x100mm Radius R3
Max span lower 770 upper 210mm
Aluminium; supports steel hardened

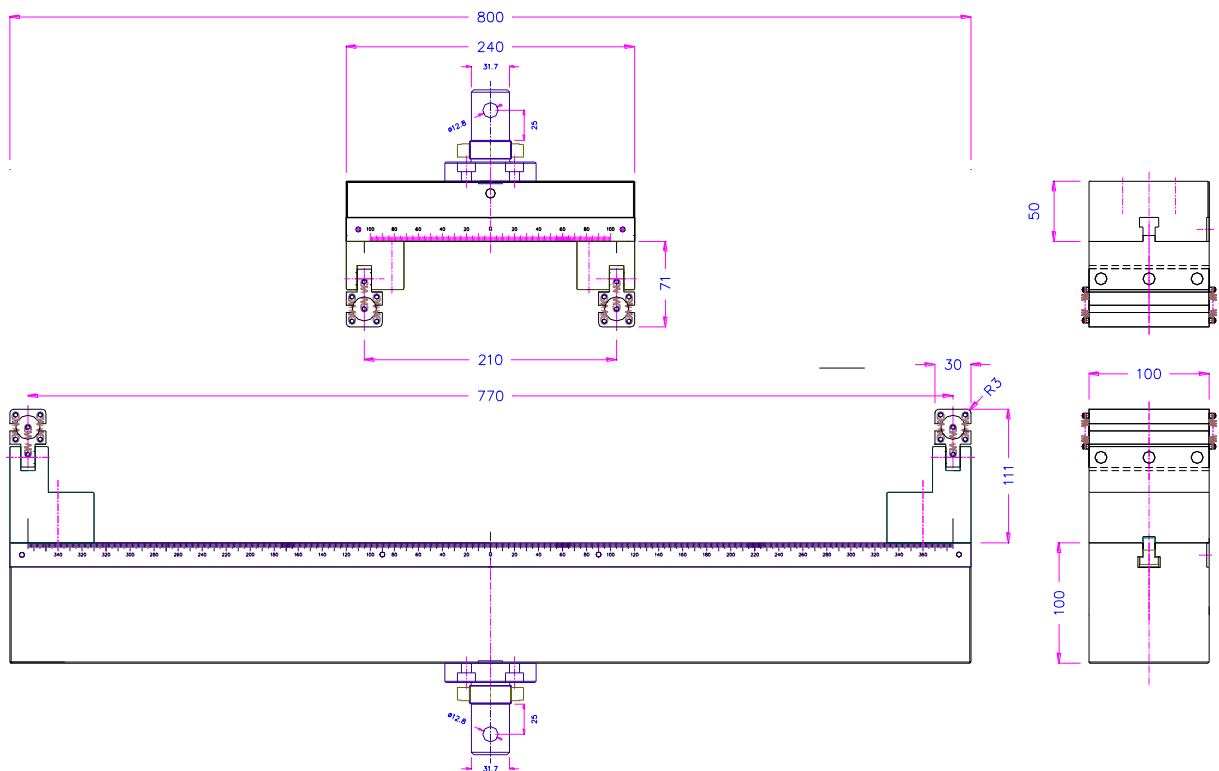

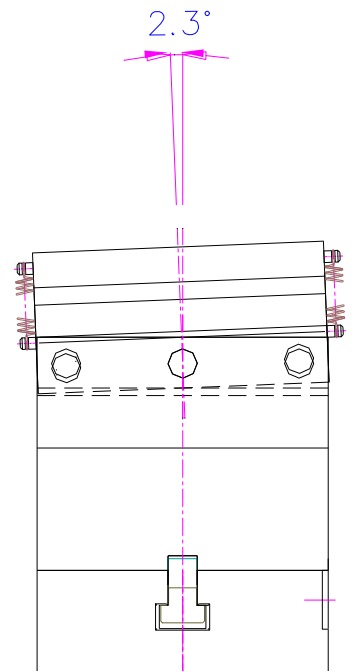
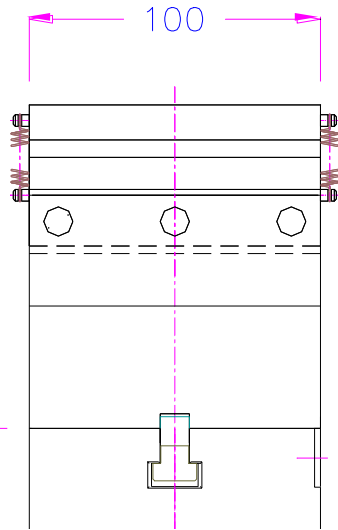
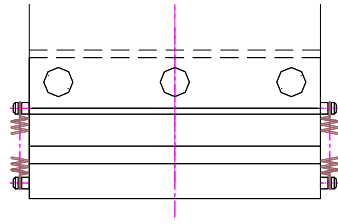
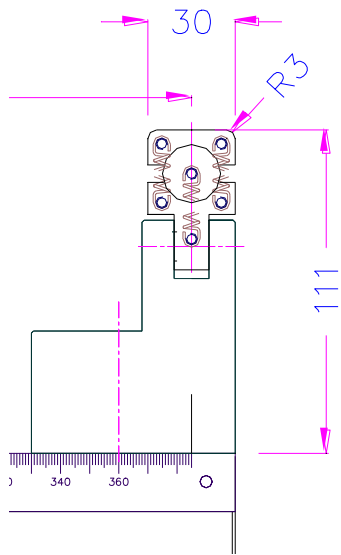

Similar parts

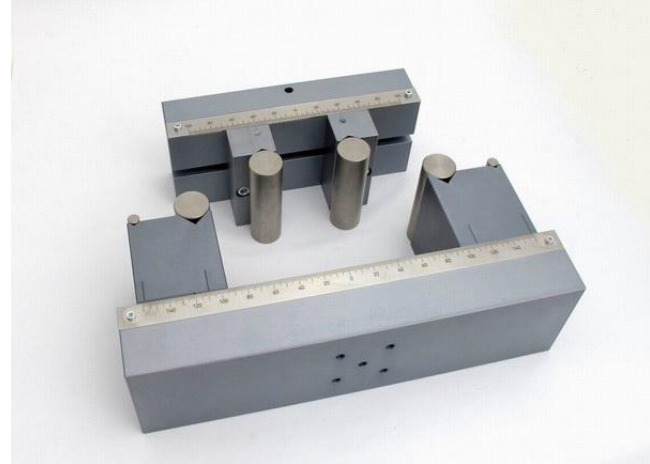

TH22-360-240

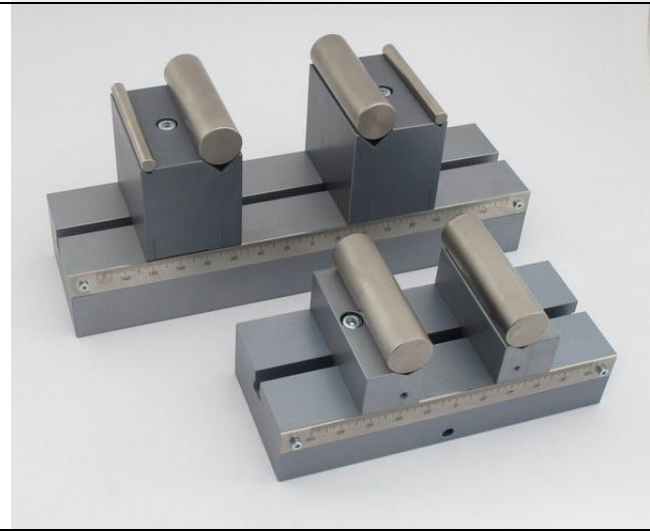

TH22-360-240