

**THS885**

THS885-70+E



THS885-70+E

chuck grip with easy changeable inserts

Schulterprobenspannzeug mit leicht wechselbaren Einsätzen

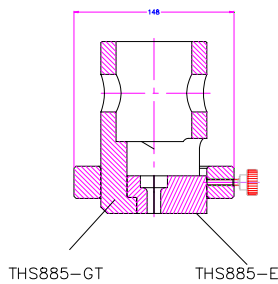
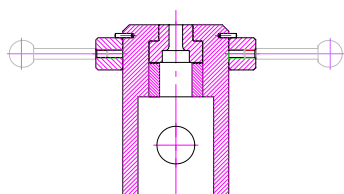
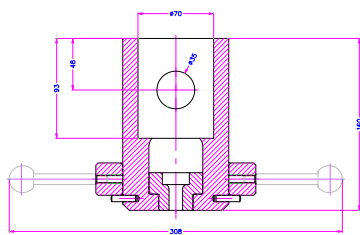
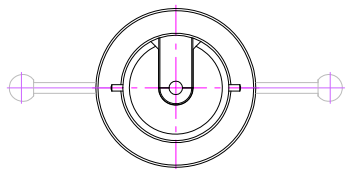

THS885-GT

THS885-E

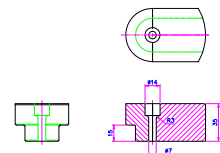

THS885-E7R3

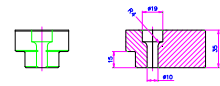

THS885-E10R4

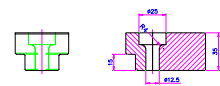

THS885-E12.5R4

THS885

THS885-E

insert

Einsatz Rohling

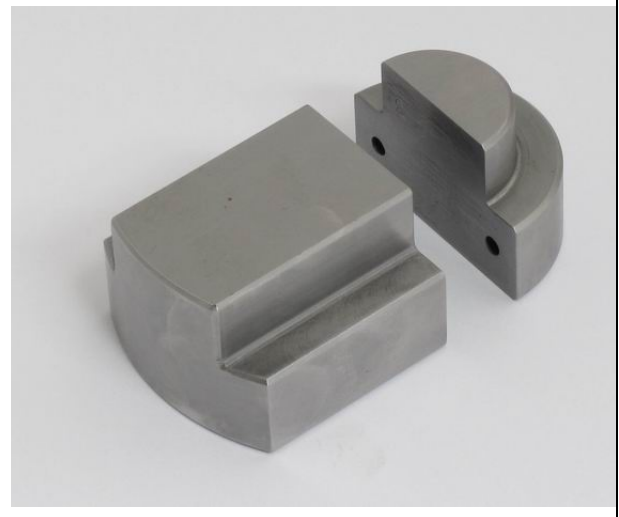

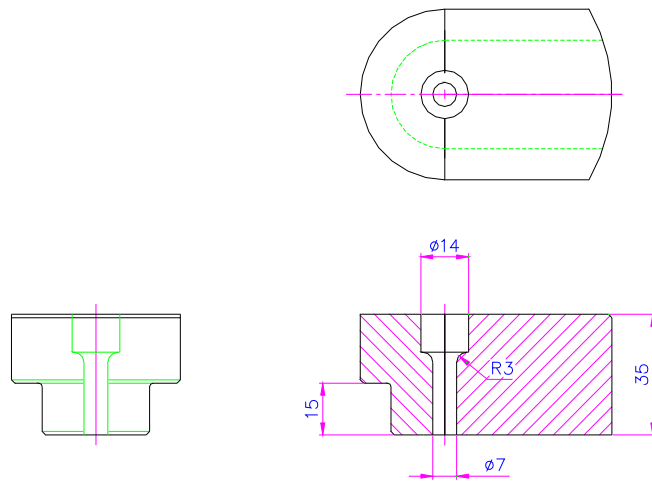

THS885-E7R3

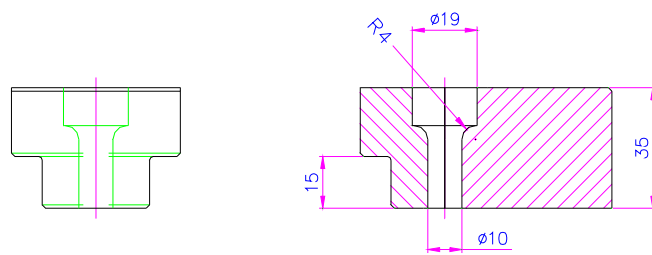

THS885-E10R4

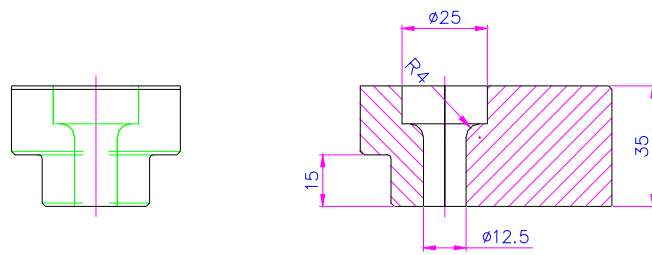

THS885-E12.5R4

Examples

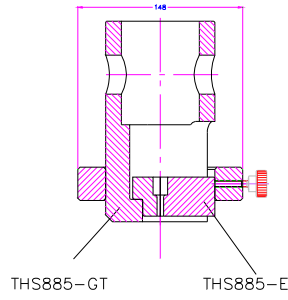
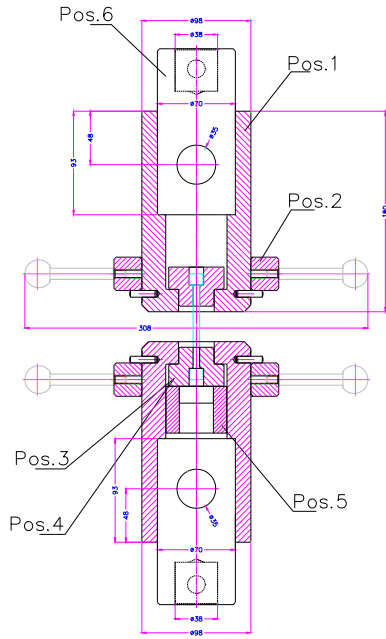
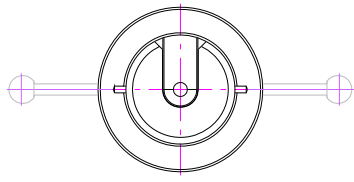

THS885-70+Af38+E6R1.5

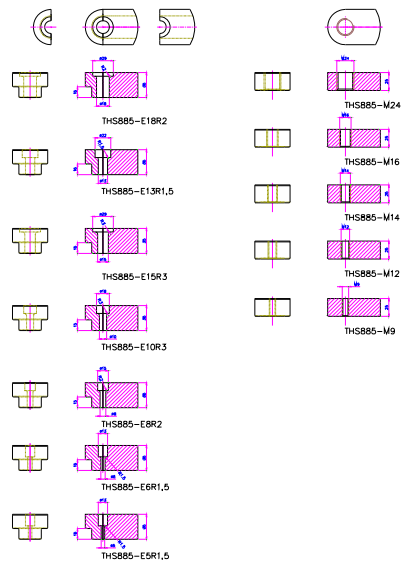
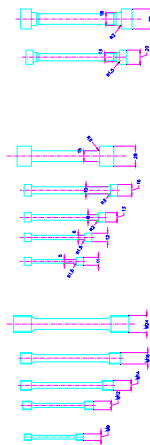
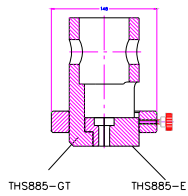
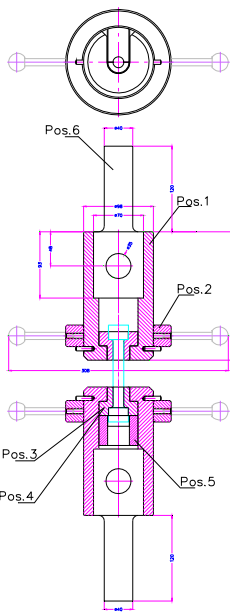
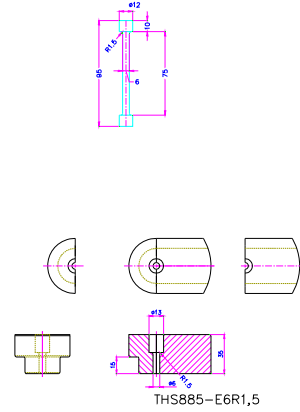

THS885-70-AVR3

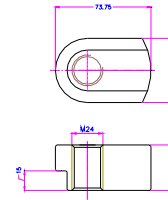
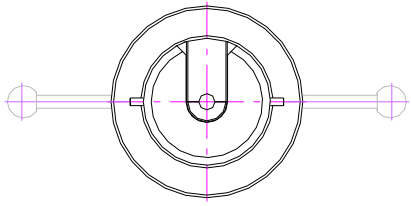

THS885-M24

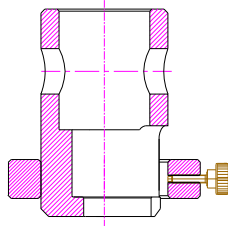
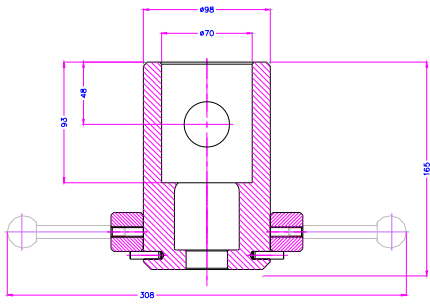

THS885-GT

THS885-M20

THS885-M18

THS885-M16

THS885-M12

THS885-M10

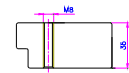

THS885-M8

THS885-EM..

THS885-70+EM8 10 12 16 18 20 22 24

<p>Similar Parts</p>	
	<p>TH4</p>
	<p>TH89</p>
	<p>TH89-SX191 Special inserts</p>
	<p>THS565</p>
<p><a href="http://www.grip.de">www.grip.de</a></p>	<p>info@grip.de</p>