

Newsletter

Spannung unter Druck

Sortiment an pneumatische und hydraulische Bedienelemente und Zubehör.
Wie man diese kombiniert und Wissenswertes für ihre nächsten Bestellung.

Besuchen Sie den nachstehenden Weblink für weitere Informationen über unsere Pneumatik-Kategorie,
<https://grip.de/G12/>

Teil 1

TH205 Pneumatische Bedienelemente und Zubehör

1. Kompressor



2. Standard Schalter



3. Adapter & Verbindungen



4. Anschlüsse



Bilder und Animationen der gelisteten Spanzzeuge hier herunterladen



Beispiele,

einige Ausführungen für verschiedene Spannzeuge,

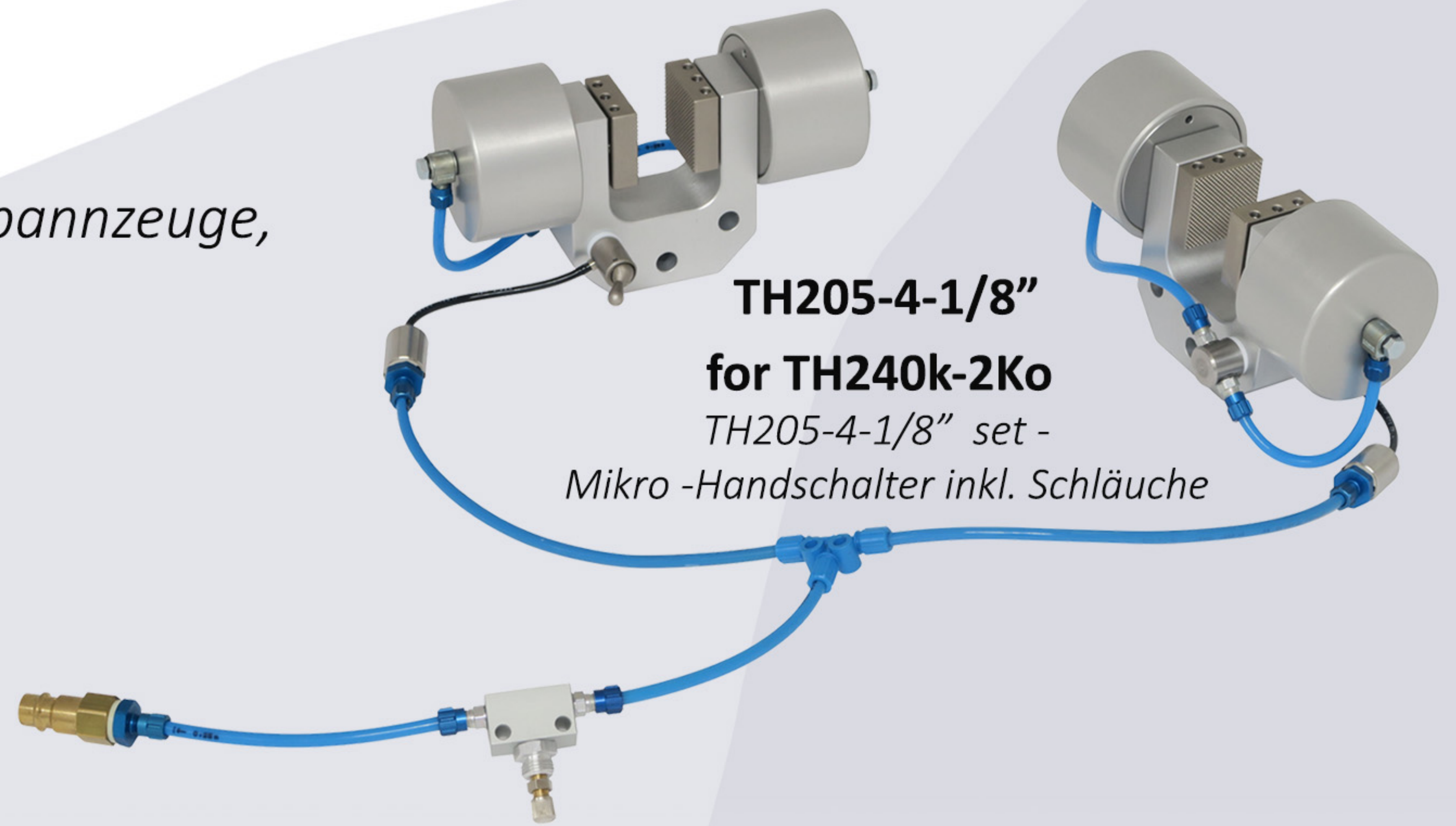

TH205-4-1/8"
for TH240k-2Ko
*TH205-4-1/8" set -
Mikro -Handscharter inkl. Schläuche*

TH149+V+2R
*Mit Verlängerungsstange für
Temperaturkammern*

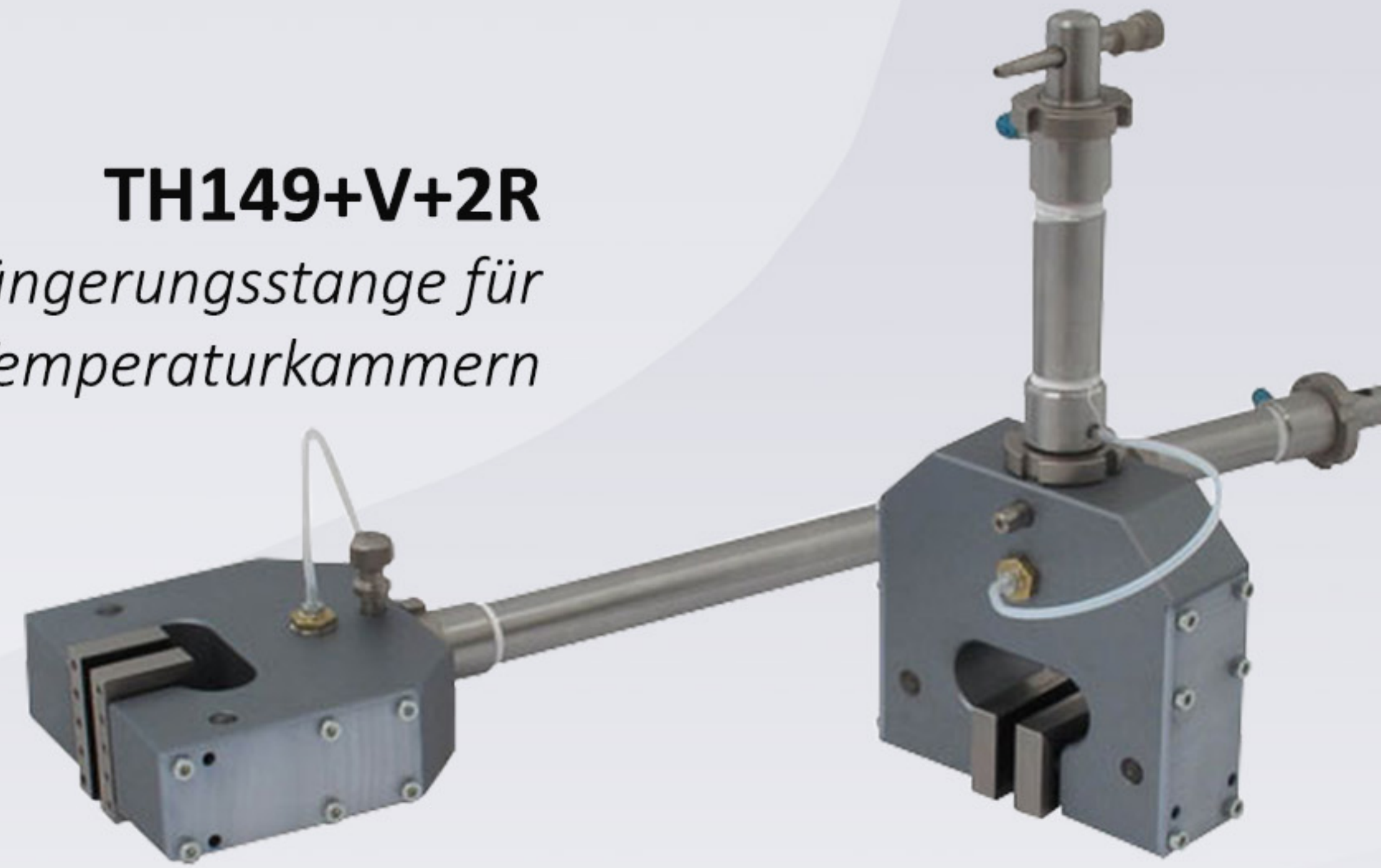

TH205-4-02-2Ko
for TH56k-2Ko
*2Ko mit einem Handscharter
gleichzeitig bedienen.*

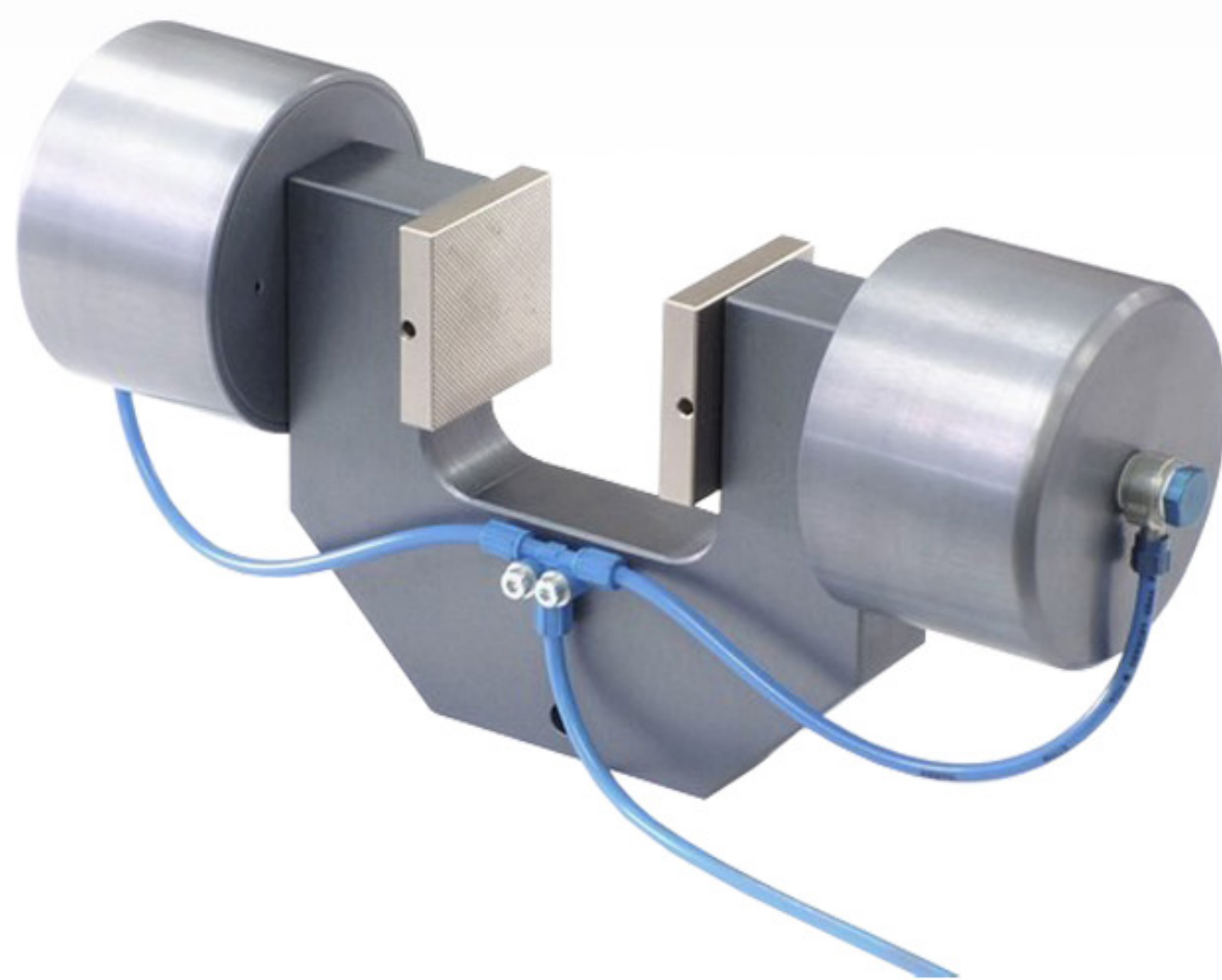
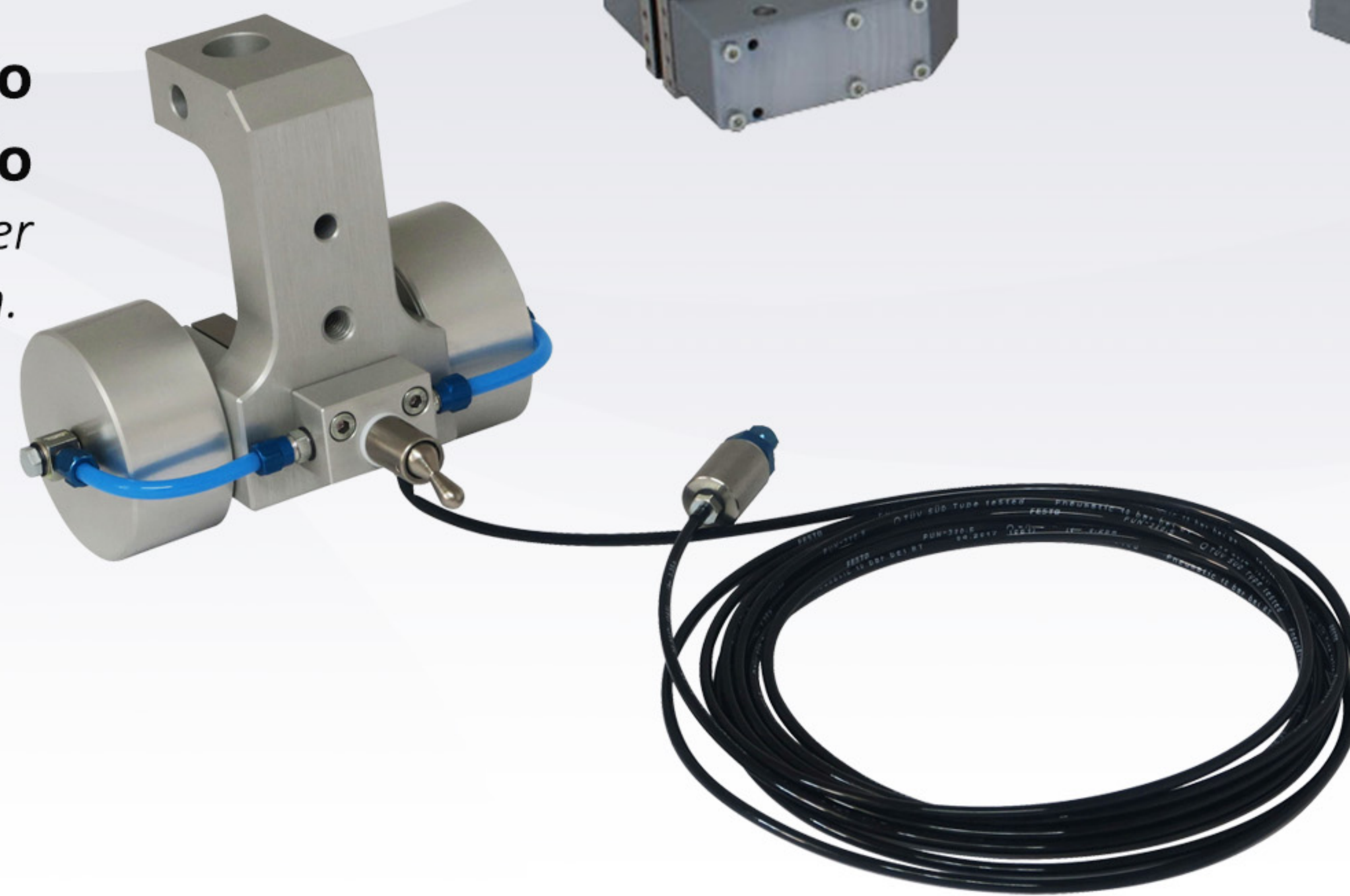

TH205-T for 2Ko

*Verwenden Sie das T-Gelenk, um die einzelnen Kolben einfach zu verbinden.
Dieser kann an einen separaten Handscharter, Fußscharter oder Sicherheitscharter
angeschlossen werden.*

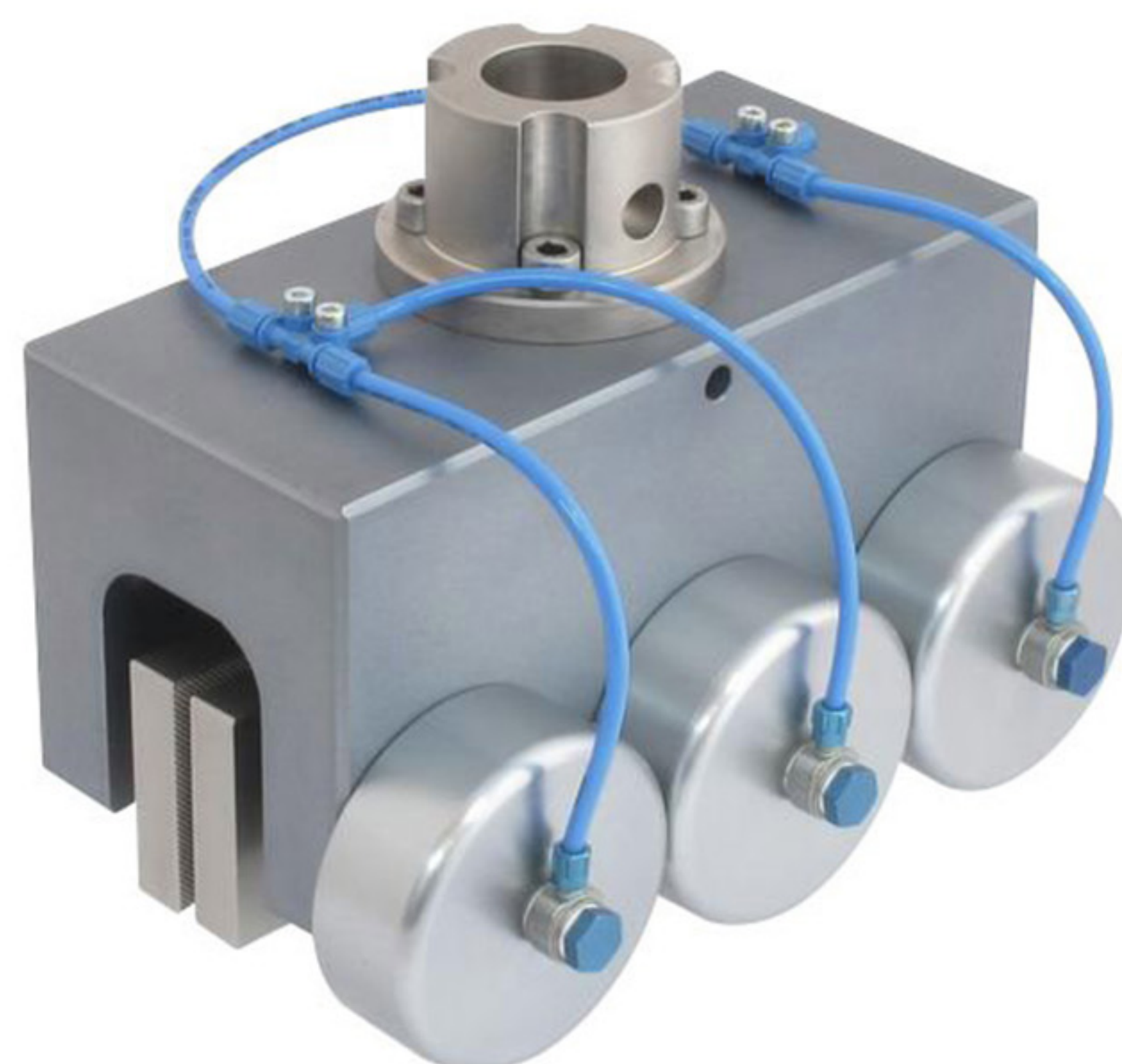

TH205-connections for THS370-Ko

Anschluss von 2, 3 oder mehrere Kolben an einen Steuerscharter.

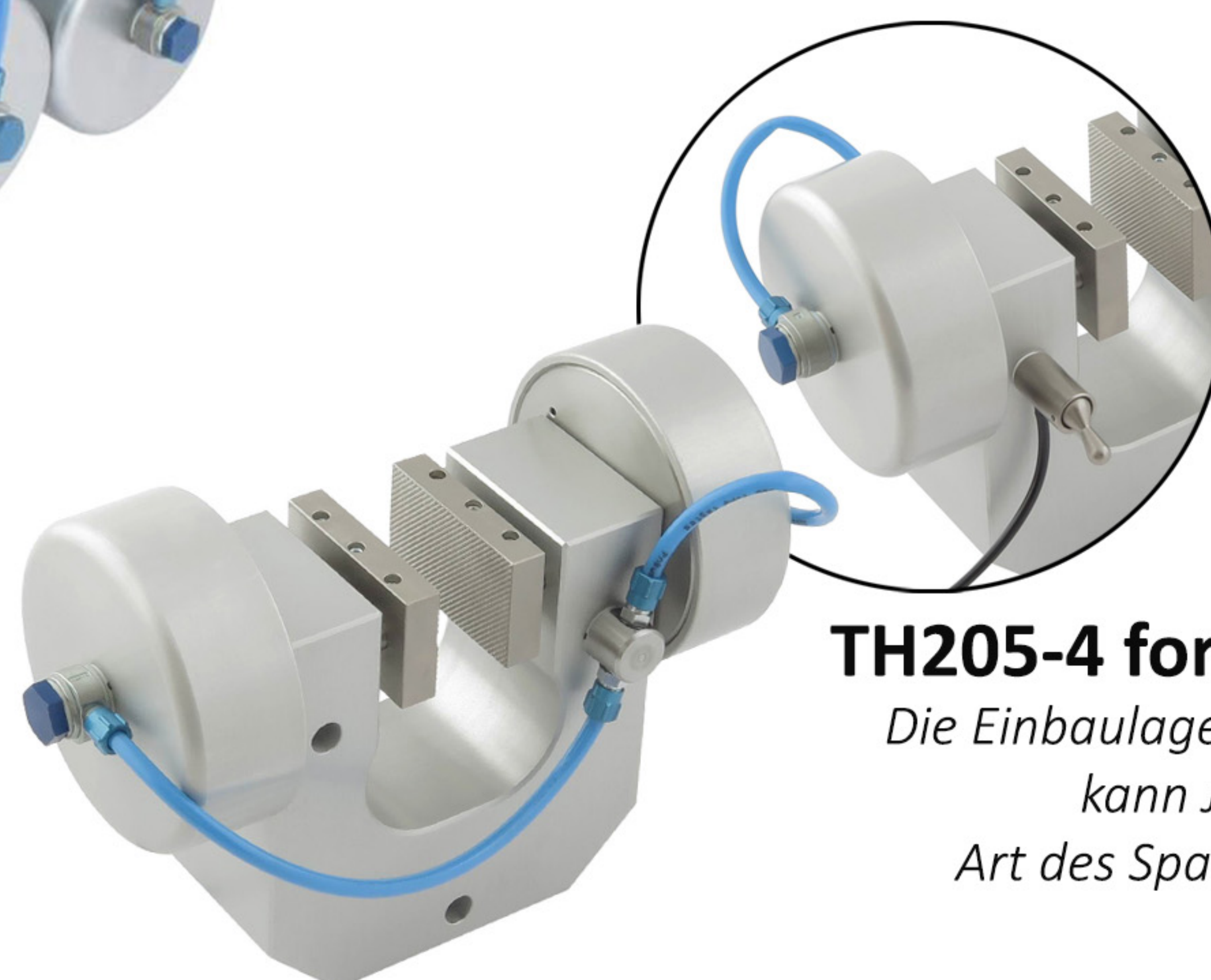

TH205-4 for TH240g+2Ko

*Die Einbaulage des Handscharters
kann Je nach Aufbau bzw
Art des Spannzeuges variieren.*

Verbindungs Beispiele

Um einige Standardverbindungs-methoden zu demonstrieren.

Beispiele mit Handschalter



E.g. 4



E.g. 3

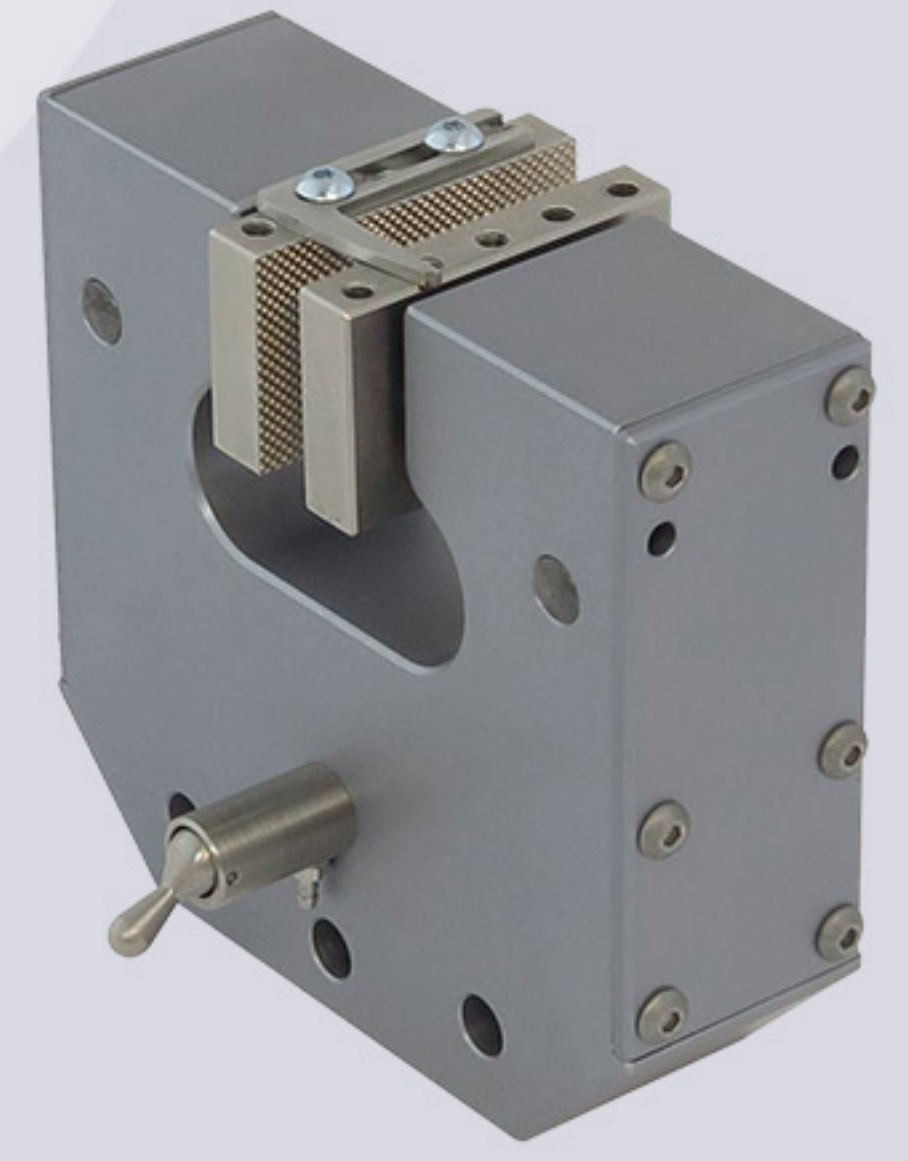

Optional TH205-Pk2 Teflon schlauch

Optional Schnellwechsel Kupplung



E.g. 1



E.g. 2



Beispiele mit Fußpedalen



Optional Schnellwechsel Kupplung

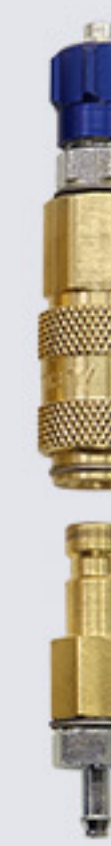



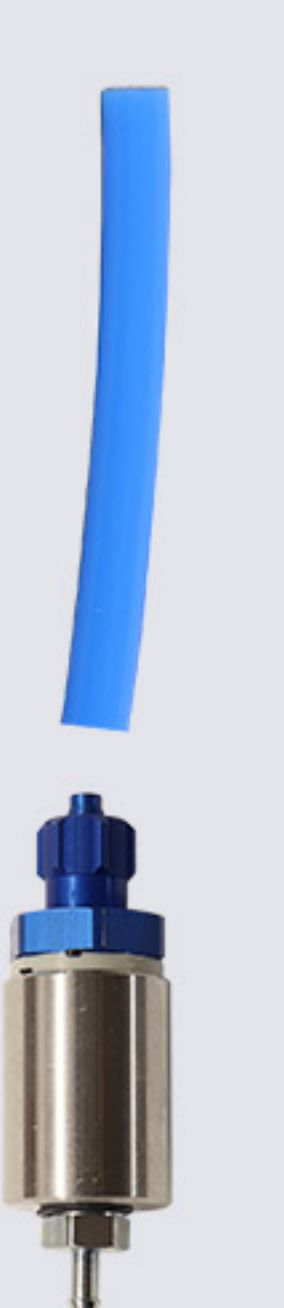



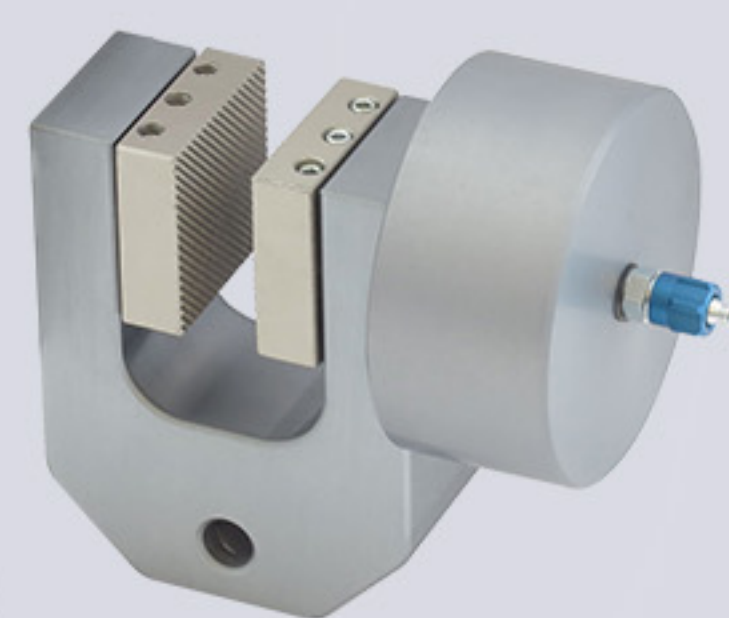











Optional Schnellwechsel Kupplung

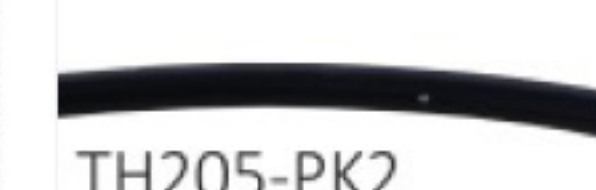

Optional TH205-Pk2 Teflon schlauch



Pneumatische Bedienelemente und Zubehör

Typ	Produkt	Beschreibung	Informationen	
FUß SCHALTER		<p>TH205-1</p> <p>Nicht rastend: Die Backen öffnen sobald das Pedal gedrückt wird und schließen wenn der Fuß von dem Pedal genommen wird.</p> <p>Nur für Single-Action-Ruten mit eingebauter Feder geeignet.</p>	Druck	Max. 10 bar
		<p>Anschluss Gewinde</p> <p>(Ventil) Kompatible Schläuche</p> <p>Gerade Einschraubverschraubung</p>	1/8" Verbindung	 TH205-PK3
				
FUß SCHALTER		<p>TH205-2 – locking</p> <p>Mit Rastfunktion : Die Backen öffnen sobald das Pedal gedrückt und bleiben geöffnet, sofern der Fuß vom Pedal genommen wird. Erst nach einer weiteren Betätigung des Pedals schließen sich die Backen.</p> <p>Nur für Single-Action-Ruten mit eingebauter Feder geeignet.</p>	Druck	Max. 10 bar
		<p>Anschluss Gewinde</p> <p>(Ventil) Kompatible Schläuche</p> <p>Gerade Einschraubverschraubung</p>	1/8" Verbindung	 TH205-PK3
				
FUß SCHALTER		<p>TH205-PR16bar</p> <p>Inklusive Druckregulator.</p> <p>Optional für TH205-1 und TH205-2.</p>	Druck	1-16 bar
		<p>Anschluss Gewinde</p> <p>(Ventil) Kompatible Schläuche</p> <p>Gerade Einschraubverschraubung</p>	1/8" Verbindung	 TH205-PK3
				
FUß SCHALTER		<p>TH205-8</p> <p>Für Double-Action-Ruten. Mit Rastfunktion.</p> <p>Für Spannzeuge ohne Rückholfeder wie z.B TH109+Ko, THS132, THS889, THS527+Ko</p>	Druck	Max. 10 bar
		<p>Anschluss Gewinde</p> <p>(Ventil) Kompatible Schläuche</p> <p>Gerade Einschraubverschraubung</p>	1/8" Verbindung	 TH205-PK3
				
HAND SCHALTER		<p>TH205-4-M5</p> <p>Pneumatische Mikro-Handventile.</p> <p>Nur für Single-Action-Ruten mit eingebauter Feder.</p> <p>Verwendet mit TH149, TH83, TH232, TH108, THS65, THS132, TH56g+Ko, TH240g+Ko</p>	Druck	Max. 16 bar
		<p>Schraub-Gewinde</p> <p>(Ventil) Kompatible Schläuche</p>	M5 Verbindung	  TH205-PK2 TH205-PK2-Teflon
HAND SCHALTER		<p>TH205-4-1/8"</p> <p>Pneumatische Mikro-Handventile.</p> <p>Nur für Single-Action-Ruten mit eingebauter Feder.</p> <p>TH229 TH56k+Ko TH240k+Ko, TH109-...-+Ko</p>	Druck	Max. 16 bar
		<p>Schraub-Gewinde</p> <p>(Ventil) Kompatible Schläuche</p>	1/8" Verbindung	  TH205-PK2 TH205-PK2-Teflon
HAND SCHALTER		<p>TH205-3</p> <p>Mit Rastfunktion.</p> <p>Nur für Single-Action-Ruten mit eingebauter Feder</p>	Druck	Max. 16 bar
		<p>Anschluss Gewinde</p> <p>(Ventil) Kompatible Schläuche</p>	1/8" Verbindung	 TH205-PK3

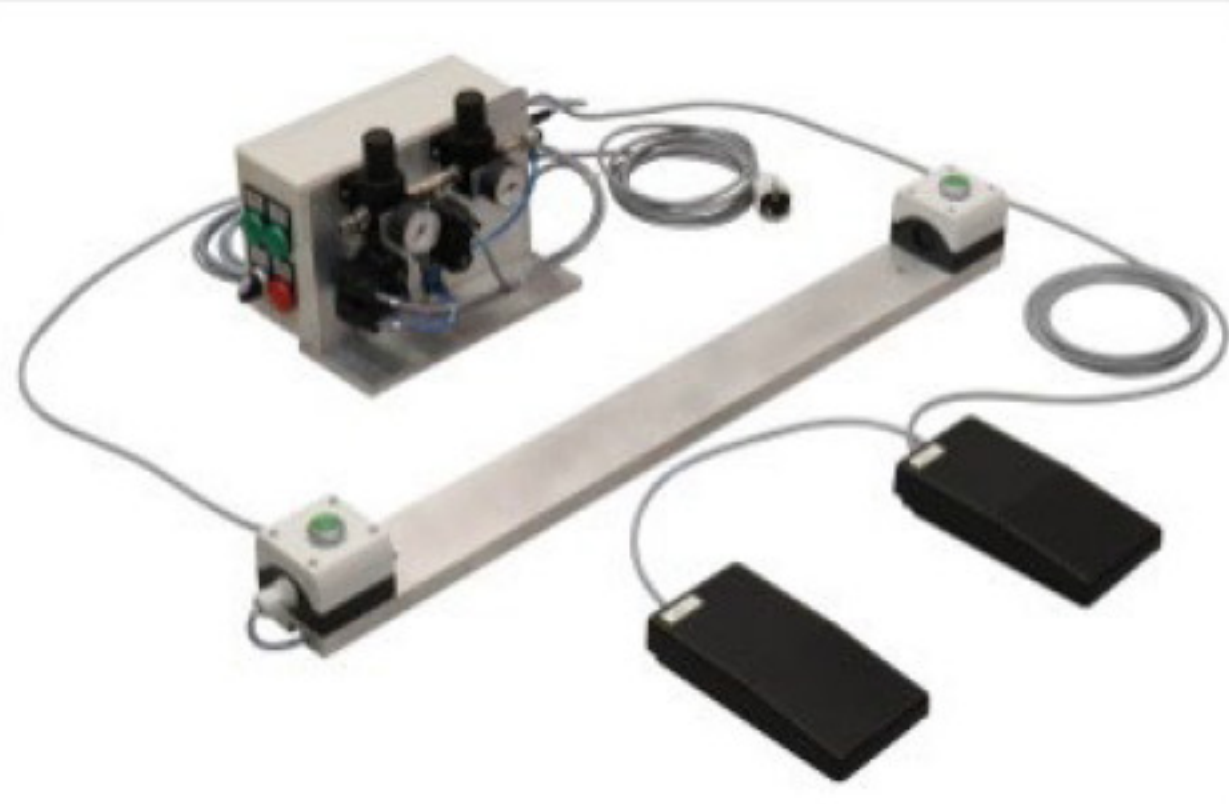
Type	Produkt	Beschreibung	Informationen	
SICHERHEITS- SCHALTER		TH205-6-2H Sicherheitssystem	Druck	Max.10 bar
		Einzelschließung mit Fußpedal 0,5bar Handschalter erhöhen den Druck von 0,5 auf 7 bar. Das Betätigen einer beliebigen Taste lässt den Druck auf 0,5 bar zurückfallen.	Elektrische Box.	220 Volt
			2 x Handschaler	
			2 x Fußschalter	

Fittings and connections			
NAME	Gewinde	Einschraubverschraubung	Kompatible Schläuche
Gerade Einschraubverschraubung			
CK-1/8-PK3	1/8"		 TH205-PK3
CK-M5-PK3	M5		 TH205-PK3
CN-M5-PK2	M5		 TH205-PK2  TH205-PK2-Teflon
Gewinkelte Einschraubverschraubung			
LCK-1/8-PK3	1/8"		 TH205-PK3
LCK-M5-PK3	M5		 TH205-PK3
LCN-M3-PK2-B	M3		 TH205-PK2  TH205-PK2-Teflon

Adapter und Verbindungselemente			
TH205-PK23	 TH205-PK3		 TH205-PK2  TH205-PK2-Teflon
TH205-9-PK3-PK3 Schnellwechsel Kupplung	 TH205-PK3		 TH205-PK3
TH205-9-PK3-PK2 Schnellwechsel Kupplung	 TH205-PK3		 TH205-PK2  TH205-PK2-Teflon
TH205-T-PK3 T-fitting Für PK3	1  TH205-PK3		= 2x  TH205-PK3
Anschlüsse für Kompressor			

