

## TH149 Pneumatic Grip 2.2 kN

Symmetric clamping action. Dual-action for self-centring of the specimen which allows a quick and easy loading.

Each grip is supplied with a specimen alignment device, which can be mounted directly on the jaws.

### Ordering information

TH149 are supplied in pairs, but can also be ordered as single grip (0.5 pair).

Jaw faces need to be ordered separately.



| Item number          | TH149                                                               |
|----------------------|---------------------------------------------------------------------|
| Clamping force       | 2.2 kN / 7 bar - max 5 kN / 16 bar                                  |
| Stroke               | 6 mm                                                                |
| Temperature range    | 0°C ... +70°C (Further temperature ranges on request (max. +180°C)) |
| Body                 | Aluminium, anodized                                                 |
| Pneumatic connection | Internal thread coupling 1/8"                                       |
| Weight               | 1.21 kg each grip (without jaws)                                    |

### Jaws for TH149:

Scope of delivery: 1 set = 4 jaws

Jaws faces with other dimensions and surface coatings are available on request

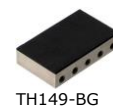

| Item-No. | Surface                 | Clamping surface H x W | Opening with TH149-Z6* rod | Opening with TH149-Z11* rod | Weight per pair |
|----------|-------------------------|------------------------|----------------------------|-----------------------------|-----------------|
| TH149-B  | Blank jaws              | 30 x 50 mm             | 0 – 6 mm                   | 4 – 11 mm                   | 0.22 kg         |
| TH149-BG | Rubber-coated jaws      | 30 x 50 mm             | 0 – 4 mm                   | 2 – 9 mm                    | 0.22 kg         |
| TH149-BP | Pyramid (serrated) jaws | 30 x 50 mm             | 0 – 6 mm                   | 4 – 11 mm                   | 0.22 kg         |
| TH149-BV | V-jaws                  | Height 30 mm           | 4 – 6 mm Ø                 | 7 – 11 mm Ø                 | 0.18 kg         |
| TH149-BW | Wave jaws               | 30 x 50 mm             | 0 – 6 mm                   | 4 – 11 mm                   | 0.20 kg         |
| TH149-BD | Diamond-coated jaws     | 30 x 50 mm             | 0 – 6 mm                   | 4 – 11 mm                   | 0.22 kg         |

\*TH149-Z6 and TH149-Z11 rods are included in the price of the grips

### Insert jaws for TH149:

For a quick insert jaw change, a carrier is needed (TH149-GT)

Scope of delivery: 1 set = 4 jaws

Jaws faces with other dimensions and surface coatings are available on request

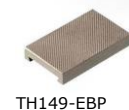

| Item-No.  | Surface             | Clamping surface H x W | Opening with TH149-Z6* | Opening with TH149-Z11* | Weight per pair |
|-----------|---------------------|------------------------|------------------------|-------------------------|-----------------|
| TH149-GT  | Carrier             |                        |                        |                         | 0.12 kg         |
| TH149-EB  | Blank insert jaws   | 30 x 50 mm             | 0 – 4 mm               | 4 – 9 mm                | 0.14 kg         |
| TH149-EBG | Rubber insert jaws  | 30 x 50 mm             | 0 – 2 mm               | 2 – 7 mm                | 0.14 kg         |
| TH149-EBP | Pyramid insert jaws | 30 x 50 mm             | 0 – 4 mm               | 4 – 9 mm                | 0.13 kg         |
| TH149-EBV | V-jaws              | Height 30 mm           | 3 – 4 mm Ø             | 4 – 9 mm Ø              | 0.13 kg         |
| TH149-EBW | Wave jaws           | 30 x 50 mm             | 0 – 4 mm               | 4 – 9 mm                | 0.12 kg         |
| TH149-EBD | Diamond jaws        | 30 x 50 mm             | 0 – 4 mm               | 4 – 9 mm                | 0.14 kg         |

\*TH149-Z6 and TH149-Z11 rods are included in the price of the grips

### Jaw surfaces



#### Blank jaws

- Suitable for own further treatments
- Steel blanks without coating



#### Rubber jaws

- 1 mm rubber coating (NBR)
- Nickel-plated



#### Pyramid jaws

- Pyramids 1.2x45
- Hardened steel 58HRC
- Nickel-plated

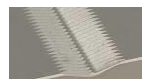

#### V-jaws

- For all round samples
- Tooth pitch 1.2 mm (TH149-BV) or 1 mm (TH149-EBV)
- Hardened steel 58HRC
- Nickel-plated



#### Wave jaws

- For flexible materials
- Wave 5 mm
- Hardened steel 58HRC
- Nickel-plated



#### Diamond jaws

- Clamping surface coated with synthetic diamonds
- Nickel-plated

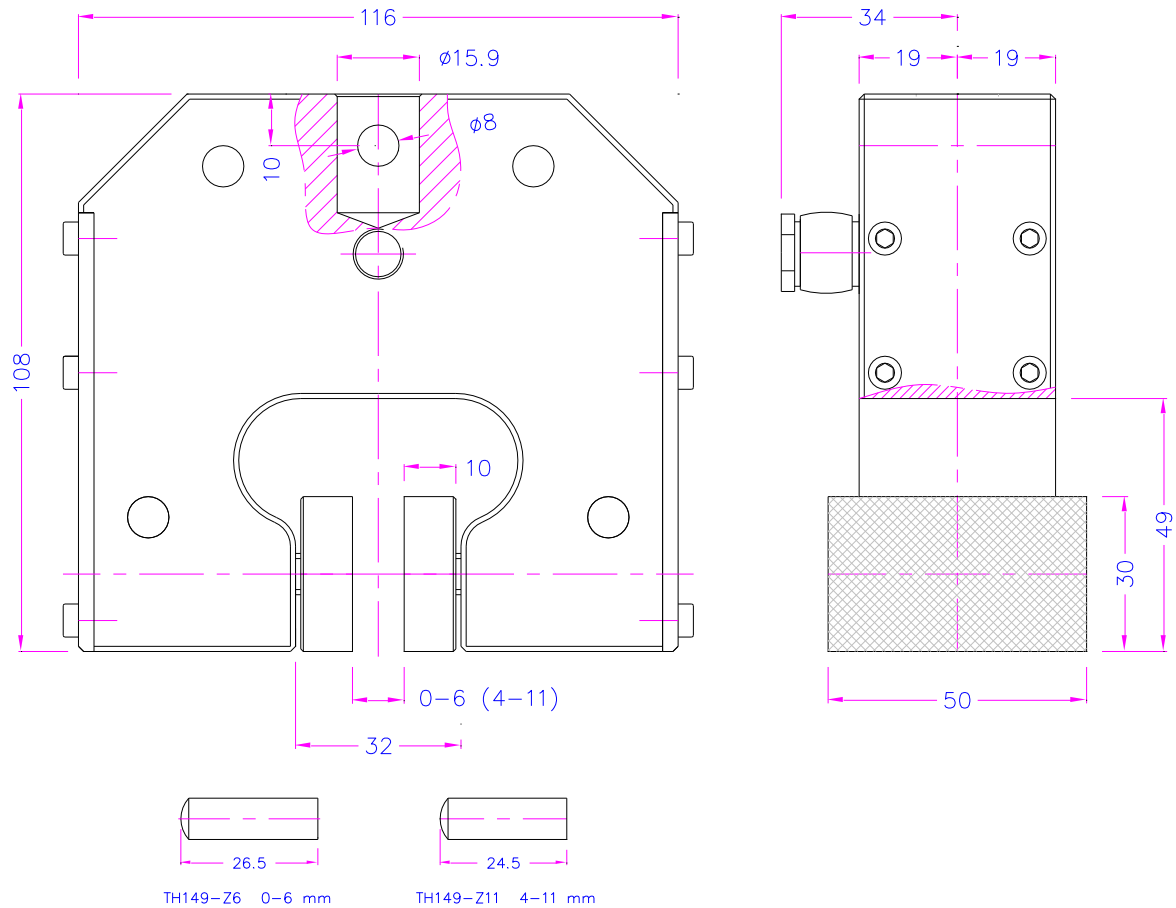

**Pneumatic accessories:**



**TH205-1 Foot pedals**

None-locking: The grip jaws open by pressing the foot pedal and close after removing the foot from the pedal.

Scope of delivery: 1 pair of foot switches including tubes and fittings



**TH205-2 Foot pedals**

With locking function: The grip jaws open by pressing the foot pedal and remain opened after removing the foot from the pedal. The jaws close by pressing the pedal one more time.

Scope of delivery: 1 pair of foot switches including tubes and fittings



**TH205-PR16bar Pressure regulator**

Optional for TH205-1 or TH205-2

To adjust air pressure: 1-16 bar



**TH205-3 Hand switches**

With locking function: The jaws of the grip close by pulling the handle and remain closed. The jaws open by pushing the handle back.

Scope of delivery: 1 unit of hand switches including tubes and fittings



**TH205-4-1/8" Pneumatic micro-hand switches**

Pneumatic micro – hand switches with 1/8" connection, tubes and fittings

With locking function: The hand switches are directly installed at the grips, 3/2 directional valve. Only for single action rods with spring inside.

Scope of supply: 2 hand switches including tubes and fittings



**TH216 Silent compressor for laboratories, oil-lubricated, with pressure reducer**

Max pressure 16 bar; 230 V/50 HZ; noise level: 38 dB(A)

Motor: 0.13 kW; displacement: 17 l/min; tank size 3.5 l

Dimensions: 340x290x340 mm (L x W x H); weight 18 kg

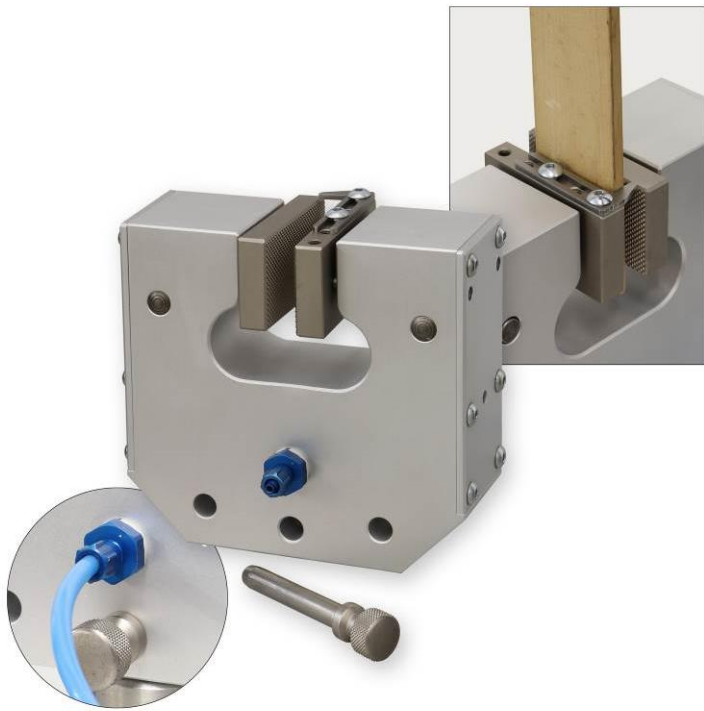

**Examples for customized solutions:**



**TH149+V+2R**



**TH149+V+2R**



**THS521-158-300**  
Pull rod 300 mm long



**TH149-BG20x50**  
Height 20 mm x Width 50 mm

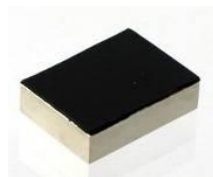

**TH149-BG30x40**  
Height 30 mm x Width 40mm

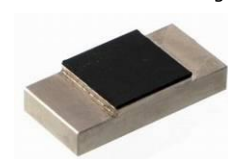

**TH149-BG25x25**  
Height 25 mm x Width 25 mm Grab test



Height 30 mm x Width 200 mm – small pyramids 0.7x45



**TH149-BWC**  
Wave jaws with cooling hole

<http://www.grip.de/G12/TH149>